

## KB TYPE – FEATURES

### Saunders® KB Design

Hand wheel sized for comfortable grip and easy operation

Lubricated for life, and protected from dust, dirt and atmospheric contaminants

Double threaded stem reduces handwheel turns

Diaphragm replaceable with valve in line

Paint finish resists environmental attack

Resilient diaphragm handles abrasives and suspended particles in the line, but still provides positive shut-off and isolates all bonnet working parts from the line fluid

Reinforced diaphragms give long life and leak-free operation

Yellow valve indicator provides visual indication of the position of the valve

Smooth non-turbulent body design for unrestricted flow and minimum pressure drop

Body lining including glass and a wide range of elastomers

Screwed and flanged options in a wide range of body materials

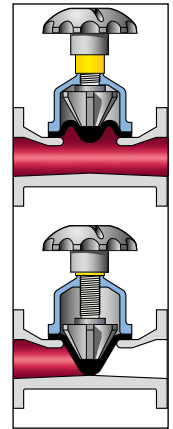

**Saunders® KB and K type (higher flow) valves:  
the choice for corrosive slurry applications**



## KB TYPE – STANDARDS



### Top Works

- Manual
- Actuated

### Diaphragm

- Rubber

### Body

- Flanged and screwed design
- Lined and unlined
- Cast iron, SG iron, cast steel, stainless steel or gunmetal

As well as meeting the overall lengths specified in EN 558-1 Series 1, Series 7\* and MSS SP-88, Saunders® valves are manufactured to the following standards:

Flanged	
<b>American</b>	ASME B16.1 Class 125
	ASME B16.24 Class 150
	ASME B16.5 Class 150
<b>British</b>	BS 10 Tables D and E
<b>British/European<sup>1</sup></b>	BS EN 1092-1 PN10/16
	BS EN 1092-2 PN10/16
	BS EN 1092-3 PN10/16
<b>Japanese</b>	JIS B 2220 10K
	JIS B 2239 10K
	JIS B 2240 10K

<sup>1</sup> Replaces BS 4504 PN10/16

Screwed	
<b>American<sup>2</sup></b>	ASME B1.20.1
<b>British/European<sup>3</sup></b>	BS EN 10226-1 Parallel
	BS EN 10226-1 Taper
<b>European<sup>4</sup></b>	EN ISO 228-1
<b>International</b>	ISO 7-1 Parallel
	ISO 7-1 Taper

<sup>2</sup> Replaces ANSI 2.1

<sup>3</sup> Replaces BS 21 Parallel and Taper

<sup>4</sup> Replaces DIN 259

\* Series 7 is the original IDV standard from when PK Saunders invented the diaphragm valve.

## KB TYPE – BODY

### Lined and Unlined Options

Saunders® full bore KB type diaphragm valves, with their smooth non-turbulent body design, have proven to be outstanding in resisting the erosion effect of abrasive media, providing low pressure drop and high flow characteristics.

### Unlined Bodies

Material	Connection	Standard	Material Grade	Size	Temperature
Cast Iron	Screwed	BS EN1561	GJL-250	DN15-DN50	-10°C to 175°C
	Flanged			DN15-DN350	
SG Iron <sup>1</sup>	Screwed	BS EN1563	GJS-450-10	DN8-DN50	-10°C to 175°C
	Flanged		GJS-400-18 <sup>1</sup>	DN15-DN350	
Gun Metal	Screwed	BS EN1982	CC491K-GS	DN15-DN50	-30°C to 175°C
	Flanged		CC492K-GS	DN15-DN100	
Stainless Steel	Flanged	BS EN10283	1.4408 <sup>2</sup>	DN15-DN250	-30°C to 175°C

<sup>1</sup> For some sizes GJS-400-18-LT grade is available with a low temperature limit of -20°C

<sup>2</sup> Replaces the standard BS3100 316C16

Standard material grade fasteners:

Stainless steel fasteners - All stainless steel, plastic lined and glass lined valves

Aluminium Bronze fasteners - Gunmetal flanged valves

Carbon Steel fasteners - All remaining valves.

Special material grade fasteners available upon request

The flexible diaphragms ensure consistent leak tightness even when solids, powders and dry media are present. The wide range of lining materials make the valve suitable for many corrosive/abrasive applications up to a maximum pressure of 10 bar.

### Lined Options - Flanged Bodies Only

Lining	Body Material	Size	Temperature
Butyl (Isobutylene Isoprene)	Cast Iron	DN25-DN350	-10°C to 110°C
	SG Iron		-10°C to 110°C
	Cast Steel		-30°C to 110°C
Neoprene (Polychloroprene)	Cast Iron	DN25-DN350	-10°C to 105°C
	SG Iron		-10°C to 105°C
	Cast Steel		-30°C to 105°C
HRL (Hard Natural Rubber)	Cast Iron	DN25-DN350	-10°C to 85°C
	SG Iron		-10°C to 85°C
	Cast Steel		-30°C to 85°C
SRL (Soft Natural Rubber)	Cast Iron	DN25-DN350	-10°C to 85°C
	SG Iron		-10°C to 85°C
	Cast Steel		-30°C to 85°C

Glass	Cast Iron	DN15-DN150	-10°C to 175°C
-------	-----------	------------	----------------

### Glass Lining

Used in many different applications, including strong acids, salts and halogenated gases. Superior corrosion and abrasion resistance within a wide range of temperatures and concentrations. *Note that glass is not suitable for applications where thermal cycling occurs.* (Blue)

### Rubber Lining

**Butyl Isobutylene Isoprene** — Great for corrosive and abrasive slurries, and acidic slurries. Additional applications are salts in water, dilute acids and alkalis, and lime. WRAS approved. (Black)

**Neoprene Polychloroprene** — Perfect solution for a combination of abrasive slurries containing hydrocarbons, sludge oils and also sea water. (Black)

### Corrosion & Chemical Resistance

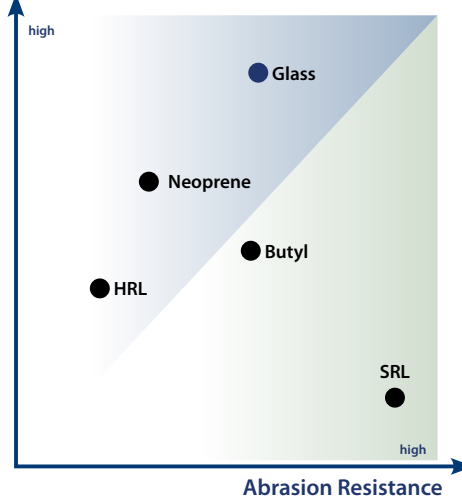

### Rubber Lining

**HRL Hard Natural Rubber** — Used for salts in water, diluted acids, de-ionised water, plating solutions and potable water. HRL has better chemical resistance than SRL. (Black)

**SRL Soft Natural Rubber** — High abrasion resistance on powders, abrasive slurries, clays, coal dust, dry fertilizers, gypsum, as well as titanium dioxide and sewage. (Brown)

The temperature ranges above are given for general reference purposes only. Service conditions, such as media being handled and concentration of solids will determine the highest possible working temperature. Additionally, the performance of the valve will also depend on the diaphragm material.

The nominal bore thicknesses of Saunders® linings range from 1 to 5.5 mm, depending on lining material and valve size: glass 1 mm, rubber 2-4.5 mm and plastic 4-5.5 mm.

## KB TYPE – DIAPHRAGM

### Diaphragm

Many factors can accelerate the aging of polymer compounds. Temperature and abrasion have a significant impact on the effect of chemicals on rubber compounds. At Saunders®, we are proud of our core competence, the in-house manufacture of Saunders® diaphragms. Our expertise in polymer science assures the best range of diaphragms to suit the most challenging duties with total security. This explains why Saunders® diaphragms are a synonymous with longer life, reduced maintenance and higher plant operating efficiencies.

**Energising ribs allow efficient shut-off in wide-bore applications**



Rubber Diaphragm

**226** - Great solution for hydrogen at high temperature, concentrated acids, aromatics solvents, low concentrated chlorine solutions, ozone, unleaded petroleum.

**300** - Chemicals, diluted acids and alkalis, drinking water. Additional abrasive applications like phosphoric acid with low concentration. FDA, USP and WRAS approved<sup>1</sup>.

**HT** - Suitable for abrasive slurries containing hydrocarbons.

**425** - Salts in water, acids and alkalis, ozone, water, intermittent steam. Great solution for on food and beverages applications. FDA and USP approved<sup>1</sup>.

**237** - The best solution for sodium hypochlorite. Great with strong acids and low concentration chlorine gas. It is also oil resistant.

**XA** - Specifically designed for both abrasive and corrosive application such as phosphoric acid, metal treatment and mining applications.

**C** - Lubricating oil, cutting oils, paraffin, animal vegetable oils and aviation kerosene at low temperatures.

**AA** - Excellent choice on abrasive applications such as slurries. The diaphragm has a light brown colour, and is sulfur cured.

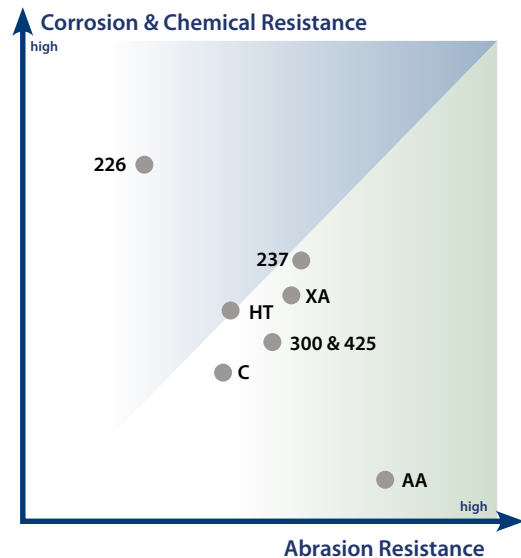

### KB Type Diaphragm

Diaphragm	Composition	Size	Temperature
425	EPM (Ethylene Propylene)	All sizes	-40°C to 130°C
300	Butyl (Isobutylene Isoprene)	All sizes	-40°C to 130°C
237	CSM (Chlorosulfonated Polyethylene)	All sizes	-10°C to 100°C
XA	EPDM (Ethylene Propylene Diene)	All sizes	-40°C to 130°C
HT	Neoprene (Polychloroprene)	All sizes	-30°C to 100°C
226	FKM (Fluoroelastomer)	DN15-DN300	-5°C to 150°C
C	Nitrile (Butadiene Acrylonitrile)	All sizes	-20°C to 100°C
AA	Natural Rubber	All sizes	-40°C to 90°C

<sup>1</sup> FDA - Food and Drug Administration USP - United States Pharmacopeia

WRAS - Water Regulations Advisory Scheme

# KB TYPE – DIAPHRAGM DIMENSIONS

## Diaphragm Identification

### KB Diaphragms

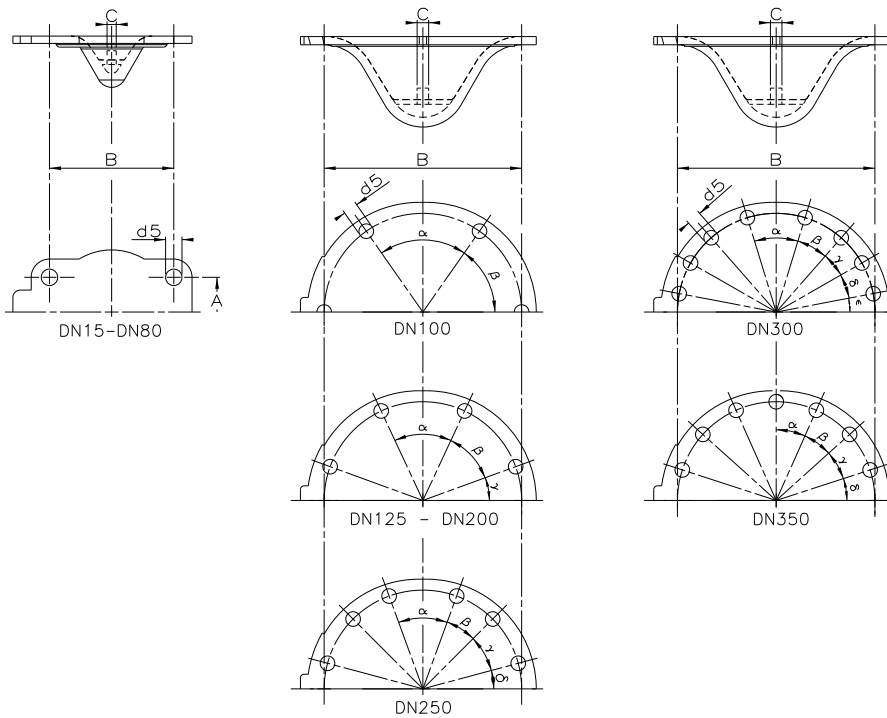

### Back Face

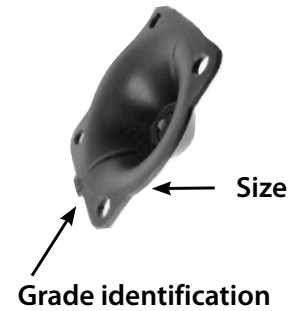

### Wetted Face



Size (DN)	Principal Diaphragm Dimensions						Angles From the Holes				
	A	B	C	D (Thickness)	d5	Number of Holes	$\alpha$	$\beta$	$\gamma$	$\delta$	$\epsilon$
15	30	54	3/16" BSW	5	7	4	-	-	-	-	-
20	30	54		5	7	4	-	-	-	-	-
25	51	64	1/4" BSW	5	9	4	-	-	-	-	-
32	51	64		5	9	4	-	-	-	-	-
40	51	64		5	9	4	-	-	-	-	-
50	64	89	5/16" BSW	5	12	4	-	-	-	-	-
65	83	102		5.6	7/16"UNC	4	-	-	-	-	-
80	102	137	3/8" BSW	6.4	5/8"UNC	4	-	-	-	-	-
100	-	171		5.5	7/16"UNC	6	70°	55°	-	-	-
125	-	205	5/8" BSW	7.9	1/2"UNC	8	50°	45°	40°	-	-
150	-	254		8		60°	40°	40°	-	-	-
200	-	305		8		60°	40°	40°	-	-	-
250	-	381	1" BSW	9.5	5/8"UNC	12	40°	25°	30°	45°	-
300	-	451		16		34°	24°20'	19°	19°	21°20'	-
350	-	527		14		24°	24°	24°	36°	-	-

BSW = British Standard Whitworth Thread

UNC = Unified Coarse Thread

Note: Dimensions in mm unless otherwise stated

## KB TYPE – TOP WORKS

### Standard Range

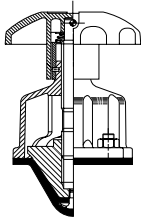

**Standard plastic rising handwheel with indicator**  
DN15 - DN50

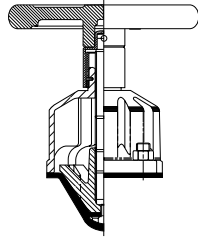

**Metal rising handwheel with indicator**  
DN65 - DN150

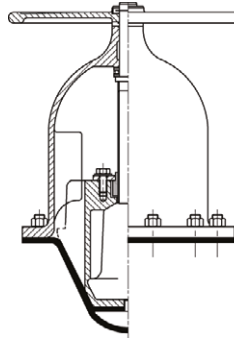

**Standard non-rising handwheel without indicator**  
DN200 - DN350

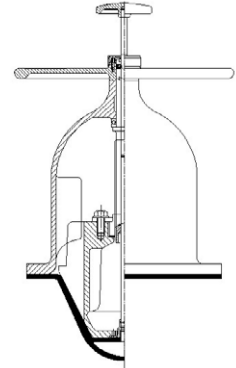

**Non-rising handwheel with indicator**  
DN200 - DN300

### High Performance

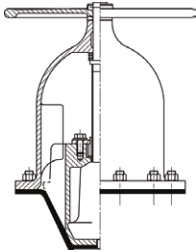

**Non-rising handwheel (fluoroeLASTOMER sealed)**  
DN15 - DN300

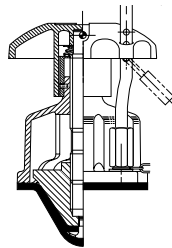

**Rising handwheel with indicator (simple padlocking)**  
DN15 - DN150

## KB TYPE – PRESSURE AND TEMPERATURE LIMITS

Maximum manual working pressures for Saunders® KB type diaphragm valves.  
For actuated valves, please refer to the appropriate datasheets.

### Bonnet pressure limits

		Size (DN)																
		8	10	15	20	25	32	40	50	65	80	100	125	150	200	250	300	350
		Handwheel																
Pressure (bar)	Rising	10	10	10	10	10	10	10	10	10	10	10	6	6	-	-	-	-
	Non-rising	-	-	-	-	-	-	-	-	-	-	-	-	-	3.5	3.5	3.5	1.5

All Saunders® valves are pressure tested in accordance with BS EN12266-1 standard.

- Shell test: 1.5 times maximum working pressure
- Seat test: 1.1 times maximum working pressure

### KB Valve Pressure/Temperature Relationship

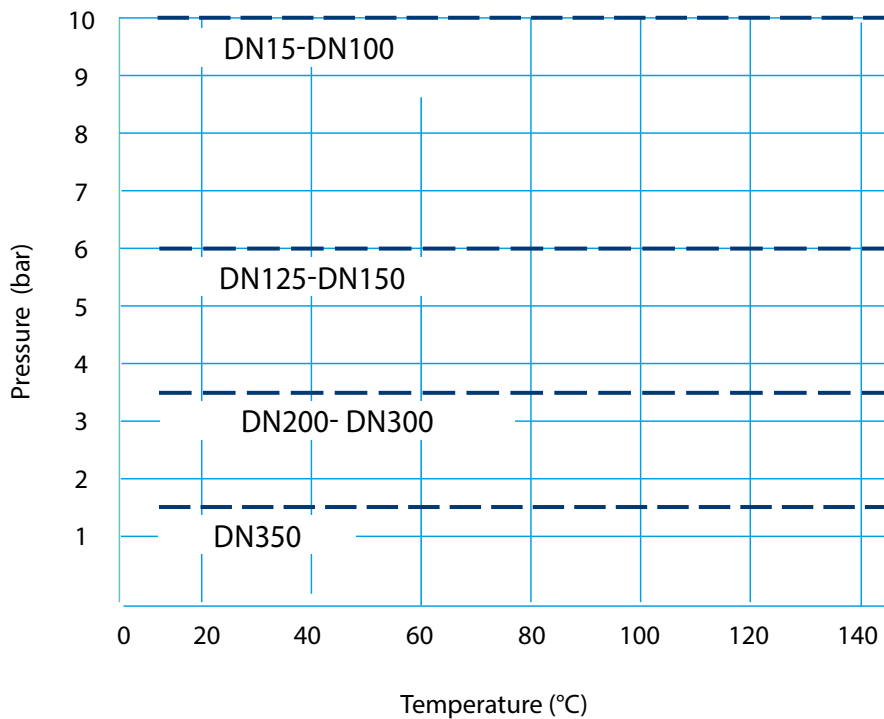

## KB TYPE – ASSEMBLED VALVE DIMENSIONS

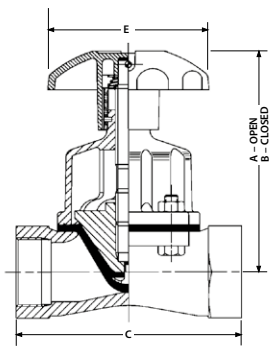

Screwed DN15 – DN50

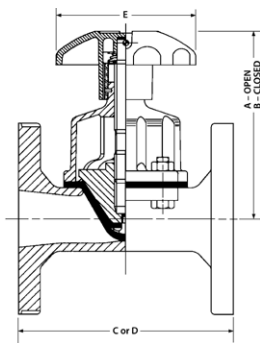

Flanged DN15 – DN50

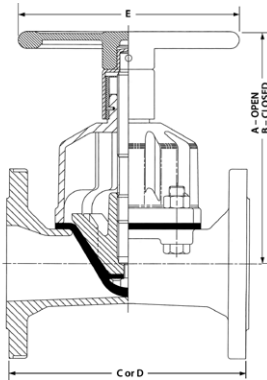

Flanged DN65 – DN150

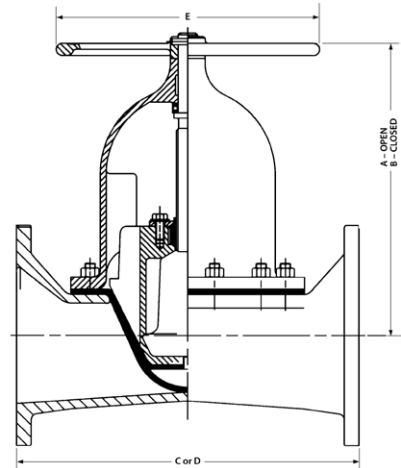

Flanged DN200 – DN350

Size (DN)		15	20	25	32	40	50	65	80	100	125	150	200	250	300	350	
Screwed Unlined	A	106	-	166	-	166	182	-	-	-	-	-	-	-	-	-	-
	B	98	-	159	-	159	162	-	-	-	-	-	-	-	-	-	-
	C	64	-	111	-	143	168	-	-	-	-	-	-	-	-	-	-
	Weight	1	-	2	-	3	5	-	-	-	-	-	-	-	-	-	-
Flanged Unlined	A	105	105	165	165	165	176	234	270	313	335	435	406	557	628	665	
	B	97	97	159	159	159	156	210	238	277	293	379	406	557	628	665	
	C	108	117	127	146	159	190	216	254	305	356	406	521	635	749	980	
	D	130	150	160	180	200	230	290	310	350	400	480	600	730	850	980	
	Weight	3	3	5	5	6	11	12	18	32	47	68	109	195	294	462	
Flanged Rubber Lined	A	-	-	168	168	168	176	234	270	313	335	435	408	559	630	667	
	B	-	-	162	162	162	156	210	238	277	293	379	408	559	630	667	
	C	-	-	131	150	163	194	220	258	309	362	412	527	641	755	986	
	D	-	-	160	180	200	230	290	310	350	400	480	600	730	850	980	
	Weight	-	-	5	5	6	11	12	18	32	47	68	109	195	294	462	
Flanged Glass* / Halar Lined	A	106	106	166	166	166	177	235	271	314	336	436	407	558	629	666	
	B	98	98	160	160	160	157	211	239	278	294	380	407	558	629	666	
	C	110	119	129	148	161	192	218	256	307	358	408	523	637	751	982	
	D	130	150	160	180	200	230	290	310	350	400	480	600	730	850	980	
	Weight	2	3	5	6	7	11	12	21	34	47	72	118	201	294	462	
	E	80	80	120	120	120	120	170	230	280	280	368	368	483	584	699	

Note: Dimensions in mm. Weights in kg. Weight may vary with materials, lining and standards. For exact weights please contact Saunders®

C valve length = EN 558 Series 7 (ex BS 5156). D valve length = EN 558 Series 1 (ex DIN 3202 Series F1).

\* Glass lining is typically available in the size range DN15 - DN150 for KB Type valves. Contact Saunders® for further requirements.



# KB TYPE – FLOW COEFFICIENTS

DN15						
% Open	Body Material / Lining					
	Cast (Unlined)		Rubber Lined		Glass / Halar	
	Cv	Kv	Cv	Kv	Cv	Kv
100	8.6	7.4	-	-	9.0	7.8
90	8.0	6.9	-	-	8.4	7.3
80	7.3	6.3	-	-	7.7	6.7
70	6.6	5.7	-	-	6.9	6.0
60	6.0	5.2	-	-	6.3	5.4
50	5.2	4.5	-	-	5.4	4.7
40	4.3	3.7	-	-	4.5	3.9
30	3.2	2.8	-	-	3.3	2.9
20	2.1	1.8	-	-	2.2	1.9
10	1.0	0.9	-	-	1.1	1.0
0	0	0	-	-	0	0

DN25						
% Open	Body Material / Lining					
	Cast (Unlined)		Rubber Lined		Glass / Halar	
	Cv	Kv	Cv	Kv	Cv	Kv
100	38	33	31	26	39	34
90	35	30	28	25	36	31
80	32	28	26	23	33	29
70	29	25	24	20	30	26
60	27	23	21	19	27	24
50	23	20	18	16	23	20
40	19	16	15	13	20	17
30	14	12	11	9.8	14	12
20	9.1	7.9	7.3	6.3	9.4	8.1
10	4.5	3.9	3.7	3.2	4.7	4.1
0	0	0	0	0	0	0

DN32						
% Open	Body Material / Lining					
	Cast (Unlined)		Rubber Lined		Glass / Halar	
	Cv	Kv	Cv	Kv	Cv	Kv
100	56	48	46	40	58	50
90	52	45	42	36	54	47
80	48	42	39	34	50	43
70	44	38	36	31	46	40
60	40	35	32	28	42	36
50	34	29	28	24	35	30
40	28	24	23	20	29	25
30	22	19	18	16	23	20
20	16	14	13	11	16	14
10	8.0	6.9	6.0	5.2	8.0	6.9
0	0	0	0	0	0	0

DN40						
% Open	Body Material / Lining					
	Cast (Unlined)		Rubber Lined		Glass / Halar	
	Cv	Kv	Cv	Kv	Cv	Kv
100	75	65	66	57	79	68
90	70	61	61	53	73	63
80	64	55	56	48	67	58
70	58	50	51	44	61	53
60	52	45	46	40	55	48
50	45	39	40	35	47	41
40	38	33	33	29	40	35
30	28	24	24	21	29	25
20	18	16	16	14	19	16
10	9.0	7.8	7.9	6.8	9.5	8.2
0	0	0	0	0	0	0

DN50						
% Open	Body Material / Lining					
	Cast (Unlined)		Rubber Lined		Glass / Halar	
	Cv	Kv	Cv	Kv	Cv	Kv
100	128	111	107	93	138	119
90	119	103	99	86	128	111
80	109	94	91	79	117	101
70	99	86	82	71	106	92
60	90	78	75	65	97	84
50	77	67	64	55	83	72
40	64	55	53	46	69	60
30	47	41	40	35	51	44
20	31	27	26	22	33	29
10	15	13	13	11	17	14
0	0	0	0	0	0	0

DN65						
% Open	Body Material / Lining					
	Cast (Unlined)		Rubber Lined		Glass / Halar	
	Cv	Kv	Cv	Kv	Cv	Kv
100	238	206	195	169	254	220
90	221	191	181	157	236	204
80	202	175	166	144	216	187
70	183	158	150	130	196	170
60	167	145	136	118	178	154
50	143	124	117	101	152	132
40	119	103	97	84	127	110
30	88	76	72	62	94	81
20	57	49	47	40	61	53
10	29	25	23	20	20	17
0	0	0	0	0	0	0

DN80						
% Open	Body Material / Lining					
	Cast (Unlined)		Rubber Lined		Glass / Halar	
	Cv	Kv	Cv	Kv	Cv	Kv
100	330	285	264	228	342	296
90	307	266	246	213	318	275
80	281	243	224	194	291	252
70	254	220	203	176	263	228
60	231	200	185	160	239	207
50	198	171	159	138	205	177
40	165	143	132	114	171	148
30	122	106	98	85	127	110
20	79	68	63	54	82	71
10	40	35	32	28	41	35
0	0	0	0	0	0	0

DN100						
% Open	Body Material / Lining					
	Cast (Unlined)		Rubber Lined		Glass / Halar	
	Cv	Kv	Cv	Kv	Cv	Kv
100	588	509	480	415	618	535
90	547	473	446	386	575	497
80	500	433	408	353	525	454
70	453	392	370	320	476	412
60	412	356	336	291	433	375
50	353	305	288	249	371	321
40	294	254	240	208	309	267
30	218	189	178	154	229	198
20	141	122	115	99	148	128
10	71	61	58	50	74	64
0	0	0	0	0	0	0

DN125						
% Open	Body Material / Lining					
	Cast (Unlined)		Rubber Lined		Glass / Halar	
	Cv	Kv	Cv	Kv	Cv	Kv
100	924	799	720	623	960	830
90	859	743	670	580	893	772
80	785	679	612	529	816	706
70	711	615	554	479	739	639
60	647	560	504	436	672	581
50	555	480	432	374	576	498
40	462	400	360	311	480	415
30	342	296	266	230	355	307
20	222	192	173	150	230	199
10	111	96	86	74	115	99
0	0	0	0	0	0	0

Note: All Kv and Cv values shown here refer to flanged valves. Valves with screwed ends demonstrate different Kv/Cv values. For more information contact Saunders®.

**Cv** = flow in US gal/min through a valve with  $\Delta P = 1$  psi

**Kv** = flow in m<sup>3</sup>/hr through a valve with  $\Delta P = 1$  bar

**1.156 Kv = Cv**

## KB TYPE – FLOW COEFFICIENTS

DN150							
% Open	Body Material / Lining						
	Cast (Unlined)		Rubber Lined		Glass / Halar <sup>1</sup>		
	Cv	Kv	Cv	Kv	Cv	Kv	
100	1680	1453	1260	1090	1800	1557	
90	1562	1351	1172	1014	1674	1448	
80	1428	1235	1071	926	1530	1324	
70	1294	1119	970	839	1386	1199	
60	1176	1017	882	763	1260	1090	
50	1008	872	756	654	1080	934	
40	840	727	630	545	900	779	
30	622	538	466	403	666	576	
20	403	349	302	261	432	374	
10	202	175	151	131	216	187	
0	0	0	0	0	0	0	

DN200							
% Open	Body Material / Lining						
	Cast (Unlined)		Rubber Lined		Glass / Halar <sup>1</sup>		
	Cv	Kv	Cv	Kv	Cv	Kv	
100	2580	2232	2196	1900	2724	2356	
90	2399	2075	2042	1766	2533	2191	
80	2193	1897	1867	1615	2315	2003	
70	1987	1719	1691	1463	2097	1814	
60	1806	1562	1537	1330	1907	1650	
50	1548	1339	1318	1140	1634	1413	
40	1290	1116	1098	950	1362	1178	
30	955	826	813	703	1008	872	
20	619	535	527	456	653	565	
10	310	268	264	228	327	283	
0	0	0	0	0	0	0	

DN250							
% Open	Body Material / Lining						
	Cast (Unlined)		Rubber Lined		Glass / Halar <sup>1</sup>		
	Cv	Kv	Cv	Kv	Cv	Kv	
100	4020	3478	3420	2958	4296	3716	
90	3739	3234	3181	2752	3995	3456	
80	3417	2956	2907	2515	3652	3159	
70	3095	2677	2633	2278	3308	2862	
60	2814	2434	2394	2071	3007	2601	
50	2412	2087	2052	1775	2578	2230	
40	2010	1739	1710	1479	2148	1858	
30	1487	1286	1265	1094	1590	1375	
20	965	835	821	710	1031	892	
10	482	417	410	355	516	446	
0	0	0	0	0	0	0	

DN300							
% Open	Body Material / Lining						
	Cast (Unlined)		Rubber Lined		Glass / Halar <sup>1</sup>		
	Cv	Kv	Cv	Kv	Cv	Kv	
100	6060	5242	4884	4225	6200	5363	
90	5636	4875	4542	3929	5800	5017	
80	5151	4456	4151	3591	4500	3893	
70	4666	4036	3761	3253	4000	3425	
60	4242	3670	3419	2958	4500	3893	
50	3636	3145	2930	2535	3900	3374	
40	3030	2621	2442	2112	3200	2768	
30	2242	1939	1807	1563	2600	2249	
20	1454	1258	1172	1014	1900	1644	
10	727	629	586	507	1000	865	
0	0	0	0	0	0	0	

DN350							
% Open	Body Material / Lining						
	Cast (Unlined)		Rubber Lined		Glass / Halar <sup>1</sup>		
	Cv	Kv	Cv	Kv	Cv	Kv	
100	10300	8910	9950	8607	-	-	
90	9579	8286	9253	8004	-	-	
80	8755	7574	8457	7316	-	-	
70	7931	6861	7661	6627	-	-	
60	7210	6237	6965	6025	-	-	
50	6180	5346	5970	5164	-	-	
40	5150	4455	4975	4304	-	-	
30	3811	3297	3681	3184	-	-	
20	2472	2138	2388	2066	-	-	
10	1236	1069	1194	1033	-	-	
0	0	0	0	0	-	-	

**Cv** = flow in US gal/min through a valve of  $\Delta P = 1$  psi

**Kv** = flow in m<sup>3</sup>/hr through a valve of  $\Delta P = 1$  bar

$$1.156 \text{ Kv} = \text{Cv}$$

<sup>1</sup> Glass lining is typically available in the size range DN15 - DN150 for KB Type valves. Contact Saunders® for further requirements.

**Note:**

The flow coefficient provides a measure of the flow of a valve. It is defined as the volume flow of water at a controlled temperature and a given pressure drop across the valve. This coefficient allows engineers to compare flow capacities of valves of different sizes, types and manufacturers.